

EINBAUANLEITUNG

Montageplatten «M4», «M8», «M16»
Spezial Montageplatten «M4», «M8», «M16»

Seite 2

FITTING INSTRUCTIONS

Mounting plates «M4», «M8», «M16»
Special mounting plates «M4», «M8», «M16»

Page 4

INSTRUCTIONS DE MONTAGE

Plaques de montage «M4», «M8», «M16»
Plaques de montage spéciales «M4», «M8», «M16»

Page 6

ISTRUZIONI PER IL MONTAGGIO

Piastrre di montaggio «M4», «M8», «M16»
Piastrre di montaggio speciali «M4», «M8», «M16»

Pagina 8

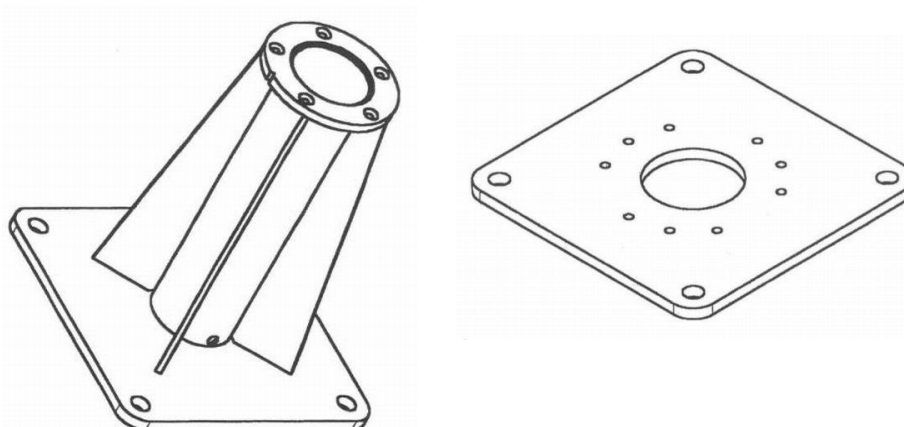

1. MONTAGEPLATTEN

1.1 Sicherheitsvorschriften



- Verschrauben Sie die Montageplatte nur auf festem Grund
 - Beton
 - Holzbalken
 - oder gleichwertige Materialien
- Überprüfen Sie die Festigkeit der Verschraubung der Montageplatte
- Der Einbau ist von Fachleuten des Maurerhandwerks oder von durch die Glatz AG entsprechend ausgebildeten Personen vorzunehmen.

1.2 Lieferumfang

- Montageplatte Stahl feuerverzinkt
 - „M4“
 - „M8“ und „M16“ für Aufstellscharnier
- Montageplatte spezial Stahl feuerverzinkt
 - „M4“ mit Deckel
 - „M8“ und „M16“ für Aufstellscharnier mit Deckel

1.3 Kundenseitige Leistungen

- geeignete Dübel- oder Verankerungsschrauben
 - Schrauben mind. 16 mm Gewindedurchmesser
- Versetzen der Montageplatte

Technische Daten

Montageplatte „M4“ (1)

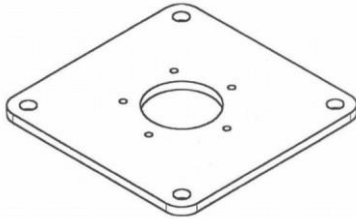

Montageplatte „M8“ zu Aufstellscharnier (2)

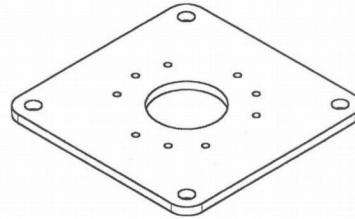

Montageplatte „M16“ (3)

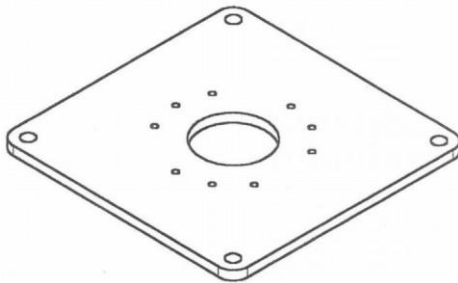

	1	2	3
Plattenhöhe	15 mm	15 mm	15 mm
Länge, Breite	300 mm	300 mm	400 mm
Abst. Schrauben aussen	250 mm	250 mm	350 mm
Ø Mittelloch	95 mm	95 mm	110 mm
Ø Gewinde	M10	M10	M10
Ø Löcher aussen	20 mm	20 mm	20 mm

Spezial Montageplatte „M4“ (4)

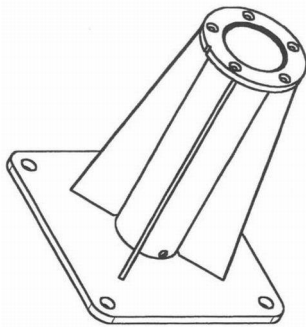

Spezial Montageplatte „M8“ zu Aufstellscharnier (5)

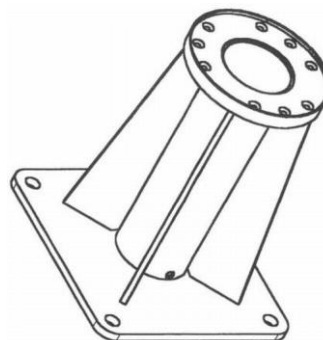

Spezial Montageplatte „M16“ (6)

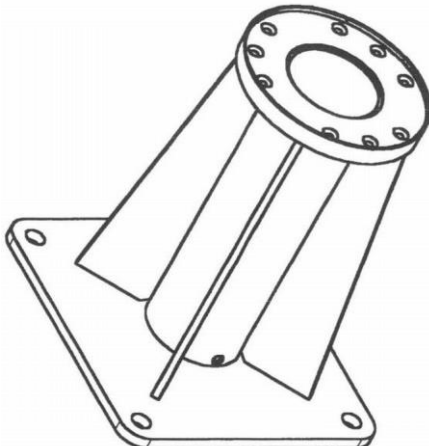

	4	5	6
Plattenhöhe	12 mm	12 mm	15 mm
Länge, Breite	300 mm	300 mm	400 mm
Höhe (max.)	350 mm	350 mm	350 mm
Abst. Schrauben aussen	250 mm	250 mm	350 mm
Ø Mittelloch	82.5 mm	94.4 mm	113 mm
Ø Gewinde	M10	M10	M10
Ø Löcher aussen	20 mm	20 mm	20 mm

2. MOUNTING PLATES

2.1 Safety regulations



- Screw the mounting plate only on solid grounds
 - concrete
 - wood truss
 - or equal materials
- Check the solidness of the screwing of the mounting plate
- Fitting is to be carried out by specialists in the craft of bricklaying or by persons trained appropriately by Glatz AG.

2.2 Scope of supply

- Mounting plate steel hot-dip galvanized
 - „M4“
 - „M8“ and „M16“ for tip-over hinge
- Mounting plate special steel hot-dip galvanized
 - „M4“ with cover
 - „M8“ and „M16“ for tip-over hinge with lid

2.3 Client's work

- Suitable plugs or anchoring screws
 - Screws with at least 16 mm thread diameter
- Setting of the mounting plate

2.4 Technical data

Mounting plate „M4“ (1)

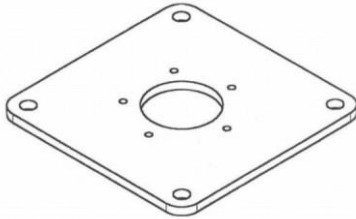

Mounting plate „M8“ for tip-over hinge (2)

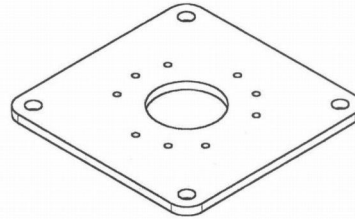

Mounting plate „M16“ (3)

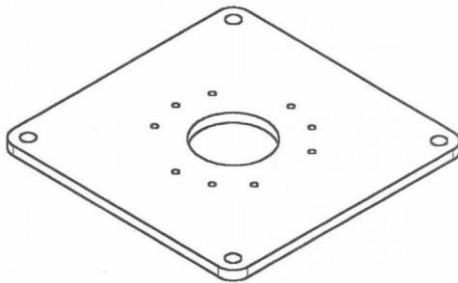

	1	2	3
height of the plate	15 mm	15 mm	15 mm
length, width	300 mm	300 mm	400 mm
distance between outer screws	250 mm	250 mm	350 mm
Ø center hole	95 mm	95 mm	110 mm
Ø threads	M10	M10	M10
Ø outer holes	20 mm	20 mm	20 mm

Special Mounting plate „M4“ (4)

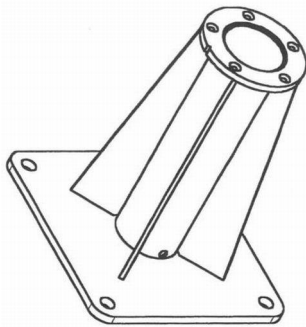

Special Mounting plate „M8“ for tip-over hinge (5)

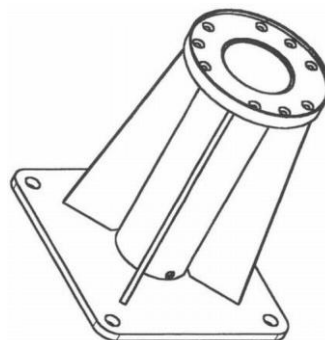

Special Mounting plate „M16“ (6)

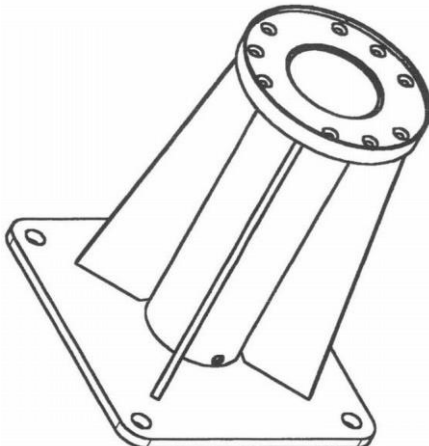

	4	5	6
height of the plate	12 mm	12 mm	15 mm
length, width	300 mm	300 mm	400 mm
height (max.)	350 mm	350 mm	350 mm
distance between outer screws	250 mm	250 mm	350 mm
Ø center hole	82.5 mm	94.4 mm	113 mm
Ø threads	M10	M10	M10
Ø outer holes	20 mm	20 mm	20 mm

3. PLAQUES DE MONTAGE

3.1 Prescriptions de sécurité



- Boulonner la plaque de montage seulement sur solide sol
 - béton
 - poutre en bois
 - ou du matériel équivalent
- Vérifiez la robustesse des assemblages par vis de la plaque de montage.
- Le montage doit être effectué par des artisans maçons qualifiés ou par des personnes spécialement formées par Glatz AG.

3.2 Matériel livré

- Plaque de montage acier galvanisé
 - „M4“
 - „M8“ et „M16“ pour charnière de montage
- Plaque de montage spéciale galvanisé
 - „M4“ avec couvercle
 - „M8“ et „M16“ pour charnière de montage avec couvercle

3.3 Prestations incombant au client

- Chevilles ou vis d'ancrages adaptées
 - Vis de filetage diamètre 16 mm minimum
- Mise en place de la plaque de montage

3.4 Données techniques

Plaque de montage „M4“ (1)

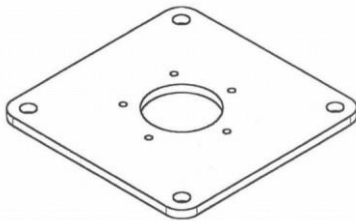

Plaque de montage „M8“ pour charnière de montage (2)

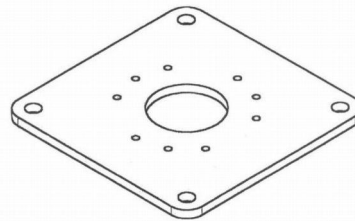

Plaque de montage „M16“ (3)

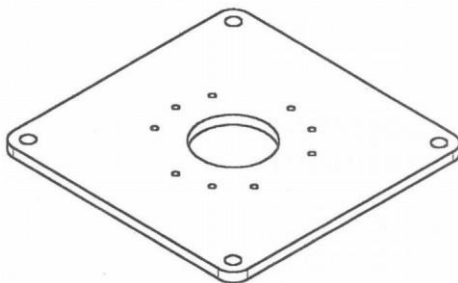

	1	2	3
hauteur de la plaque	15 mm	15 mm	15 mm
longueur, largeur	300 mm	300 mm	400 mm
distance des boulons extérieurs	250 mm	250 mm	350 mm
Ø centre trou	95 mm	95 mm	110 mm
Ø filet	M10	M10	M10
Ø trous extérieurs	20 mm	20 mm	20 mm

Plaque de montage spéciale „M4“ (4)

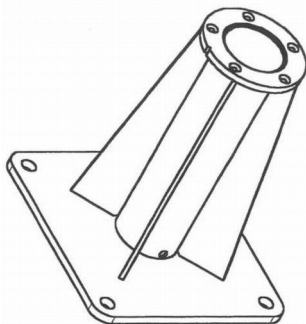

Plaque de montage spéciale „M8“ pour charnière de montage (5)

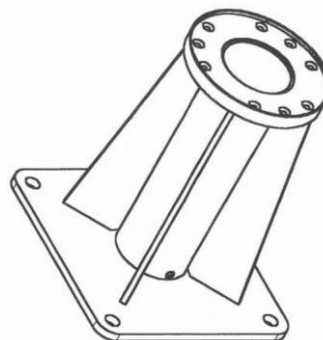

Plaque de montage spéciale „M16“ (6)

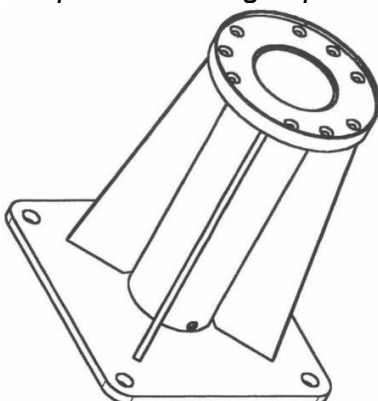

	4	5	6
hauteur de la plaque	12 mm	12 mm	15 mm
longueur, largeur	300 mm	300 mm	400 mm
hauteur (max.)	350 mm	350 mm	350 mm
distance des boulons extérieurs	250 mm	250 mm	350 mm
Ø centre trou	82.5 mm	94.4 mm	113 mm
Ø filet	M10	M10	M10
Ø trous extérieurs	20 mm	20 mm	20 mm

4. PIASTRE DI MONTAGGIO

4.1 Norme di sicurezza



- Avvitare le piastre di montaggio solo su suolo solido
 - calcestruzzo
 - travi di legno
 - o materiali equivalenti
- Controllare la solidità dell'avvitamento della piastra di montaggio
- La posa in opera deve essere effettuata da muratori professionisti o da persone appositamente addestrate dalla Glatz AG.

4.2 Equipaggiamento di serie

- Piastra di montaggio in acciaio zincato a caldo
 - „M4“
 - „M8“ e „M16“ per cerniera di montaggio
- Piastra di montaggio speciale in acciaio zincato a caldo
 - „M4“ con coperchio
 - „M8“ e „M16“ per cerniera di montaggio con coperchio

4.3 Prestazioni a cura del cliente

- Viti a caviglia o viti di ancoraggio adatte
 - Viti con un diametro minimo della filettatura di 16 mm
- Posa in opera della piastra di montaggio

Dati tecnici

Piastra di montaggio „M4“ (1) Piastra di montaggio „M8“ per cerniera di montaggio (2)

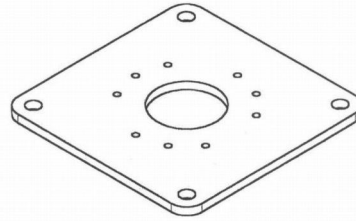
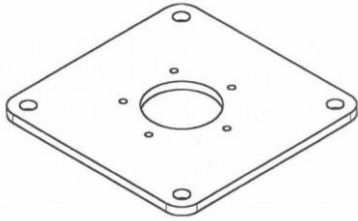

Piastra di montaggio „M16“ (3)

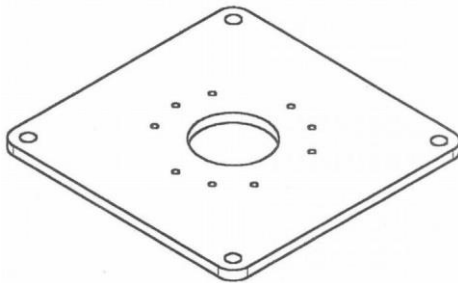

	1	2	3
Altezza piastra	15 mm	15 mm	15 mm
Lunghezza, larghezza	300 mm	300 mm	400 mm
Distanza tra le viti esterne	250 mm	250 mm	350 mm
Ø foro centrale	95 mm	95 mm	110 mm
Ø filettatura	M10	M10	M10
Ø fori esterni	20 mm	20 mm	20 mm

Piastra di montaggio speciale „M4“ (4) Piastra di montaggio speciale „M8“ per cerniera di montaggio (5)

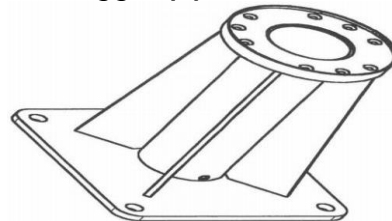
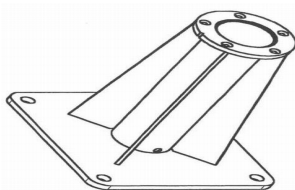

Piastra di montaggio speciale „M16“ (6)

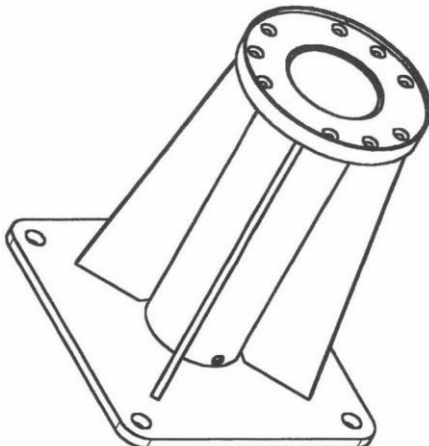

	4	5	6
Altezza piastra	12 mm	12 mm	15 mm
Lunghezza, larghezza	300 mm	300 mm	400 mm
Altezza (max.)	350 mm	350 mm	350 mm
Distanza tra le viti esterne	250 mm	250 mm	350 mm
Ø foro centrale	82.5 mm	94.4 mm	113 mm
Ø filettatura	M10	M10	M10
Ø fori esterni	20 mm	20 mm	20 mm

D

INFORMATIONSSERVICE

Herzlichen Dank, dass Sie ein Produkt von Glatz AG gekauft haben!
Wünschen Sie bezüglich Sicherheit oder Einsatz des Produktes weitere Informationen, so wenden Sie sich bitte an Ihren Fachhändler.
Antworten zu den häufigsten Produktfragen finden Sie auch auf unserer Homepage www.glatz.ch unter dem Stichwort FAQ (frequently asked questions).

Glatz AG, Neuhofstrasse 12, 8500 FRAUENFELD / SWITZERLAND

Technische Änderungen vorbehalten
© **Glatz AG** Dokument Art. 261 00 350140
Gedruckt auf 100% chlorfrei hergestelltem Papier.
Unserer Umwelt zuliebe.

E

INFORMATION SERVICE

Thank you very much for purchasing a product from Glatz AG!
If you require any further information concerning safety or use of the product, please contact your specialist dealer.
You can find the answers to the most frequent questions about our products on our homepage www.glatz.ch under the key word FAQ (frequently asked questions).

Glatz AG, Neuhofstrasse 12, 8500 FRAUENFELD / SWITZERLAND

Technical changes reserved.
© **Glatz AG** Document art. 261 00 350140
Printed on 100% chlorine-free paper.
For the benefit of our environment.

F

SERVICE D'INFORMATIONS

Merci beaucoup d'avoir acheté un produit de Glatz AG!
Si vous désirez des informations additionnelles en matière de sécurité ou d'emploi du produit, adressez-vous à votre commerçant spécialisé.
Vous trouverez les réponses aux questions les plus fréquentes concernant nos produits sur notre site internet www.glatz.ch sous le mot-clé FAQ (frequently asked questions).

Glatz AG, Neuhofstrasse 12, 8500 FRAUENFELD / SWITZERLAND

Sous réserve de modifications techniques.
© **Glatz AG** Document art. 261 00 350140
Imprimé sur papier fabriqué 100% sans chlore.

Pour l'amour de notre environnement.

I

SERVIZIO INFORMAZIONI

Vi ringraziamo sentitamente per avere scelto un prodotto della Glatz AG!

Se desiderate ricevere ulteriori informazioni in merito alla sicurezza o all'impiego del prodotto mettetevi per favore in contatto con il vostro rivenditore specializzato.

Le risposte alle domande poste con maggiore frequenza in relazione ai nostri prodotti sono elencate nel nostro sito internet www.glatz.ch sotto la rubrica FAQ (frequently asked questions).

Glatz AG, Neuhofstrasse 12, 8500 FRAUENFELD / SWITZERLAND

Con riserva di modifiche tecniche.

© **Glatz AG** Documento art. 261 00 350140

Stampato su carta completamente esente da cloro.

Per amore del nostro ambiente.